

THE INFORMATION ON THIS DOCUMENT IS THE PROPERTY OF BHARAT HEAVY ELECTRICALS LIMITED IT MUST NOT BE USED DIRECTLY OR INDIRECTLY IN ANY WAY DETRIMENTAL TO THE INTEREST OF THE COMPANY

FIRST ANGLE PROJECTION

(ALL DIMENSIONS ARE IN mm)

DRG. NO. 35225002555

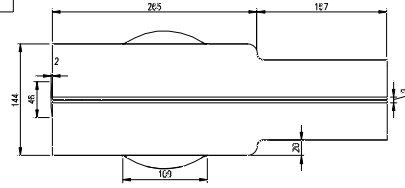

BOTTOM VIEW

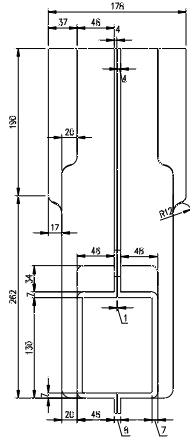

LEFT VIEW

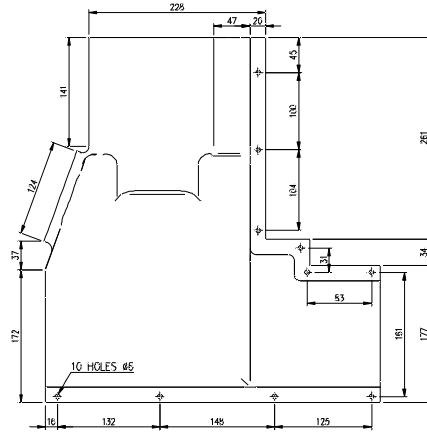

FRONT VIEW

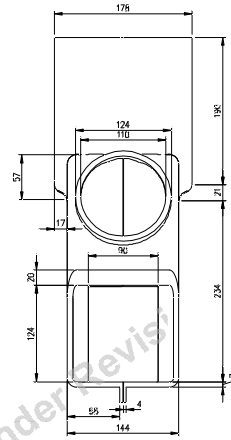

RIGHT VIEW

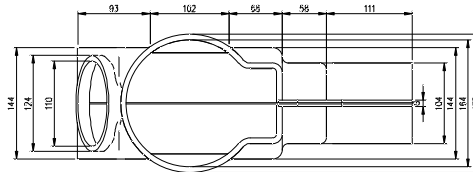

TOP VIEW

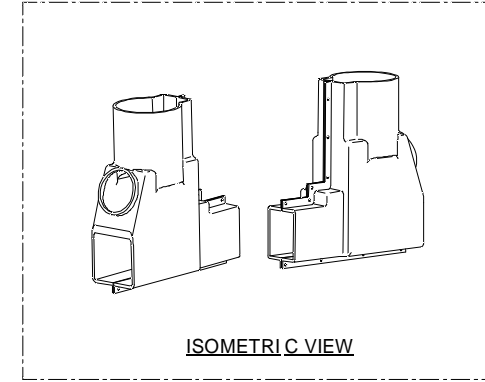

ISOMETRIC VIEW

ITEM:002

INVENTORY NO.	SIGN. & DATE	REF. DRG. NO.	ADDITIONAL INFORMATION			mRikn dk i-dkj ;k xk-gd@ifj;kstuk dk uke TYPE OF PRODUCT OR NAME OF CUSTOMER/PROJECT			VM36			
			STATUS OF DRAWING			DISTRIBUTION OF PRINTS			 HAKjr gsch bysfDV&dYl fyfeVsM HAKsiky BHARAT HEAVY ELECTRICALS LTD. BHOPAL			
0.COPY-----1 SWM-----3 TCX-----1			uke@NAME gLrk@SIGN fnouko@ATE 07.03.16 07.03.16 07.03.16			csfj_ dn lo[k NO. OF VAR -- 001						
REV.	DATE	ALTERED	REV.	DATE	ALTERED	foHAKx DEPT SWE	vu_ Vky_ uki dh Js.kh UNTL.DIMS. GR.	vuqkr SCALE	HAKj fo_xk-- WEIGHT (KG)	vis_ M&khZox dk lonHAZ REF. TO ASSY. DRG.	en d-- ITEM NO.	en_ lo[k NO. OF ITEM
		CHECKED			CHECKED	409	AA0230208	1:1		vkjs[A d-- DRAWING NO.		iqu_ @EV
		APPROVED			APPROVED	PVC POLE SHROUD			35225002555			
						(DCA 34145)			i="B d-- No. 02			
									i="Bkso dh lo[;k OF SHT. 02			